

# CTP-400-L-09

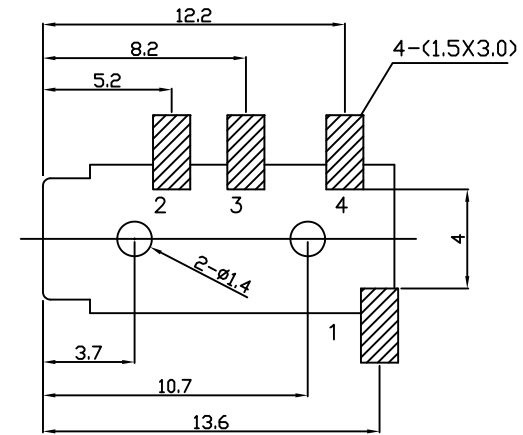

PCB LAYOUT TOP VIEW

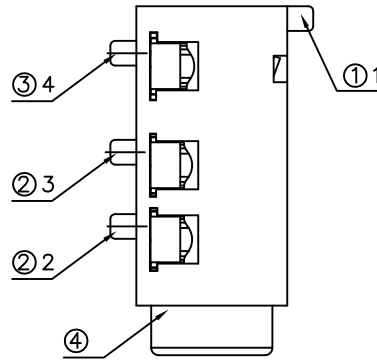
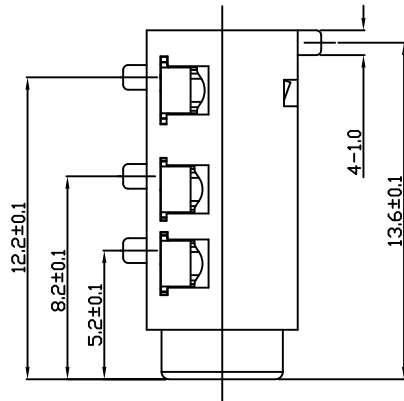
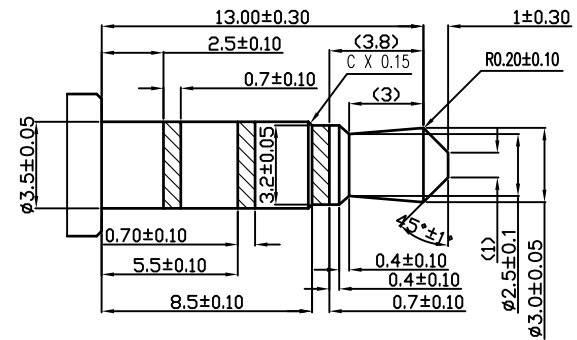
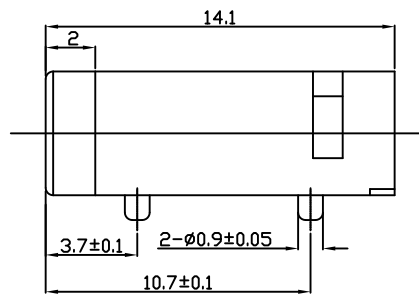
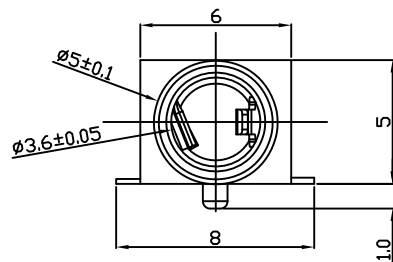

PLUG SPEC

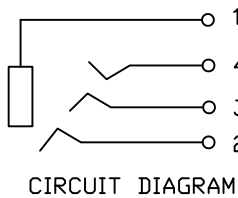
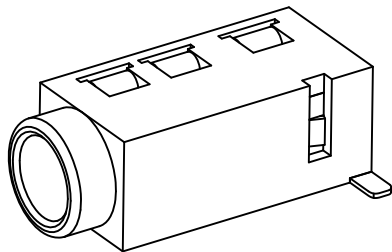

①	HOUSING PH-PJ-3505-L <sub>6</sub>	1	PA-9T (BLACK)	
②	TERMINAL MT-PJ-3505-2Q1S	1	PHOSPHOR BRONZE t=0.25	Ag-Plated
③	TERMINAL MT-PJ-3505-2Q1S	2	PHOSPHOR BRONZE t=0.25	Ag-Plated
④	TERMINAL MT-PJ-3505-1Q1S	1	PHOSPHOR BRONZE t=0.25	Ag-Plated
No.	PART NAME	QTY	MATERIAL (THICK, COLOR)	REMARK



Phone 1-800-809-2751

Fax 1-510-440-0579

www.connect-tech-products.com • info@connect-tech-products.com

4428 Technology Drive • Fremont, CA 94538, USA • 510-498-8815 • Fax: 510-440-0579