

# CTP-BP-05 CTP-7BP-05

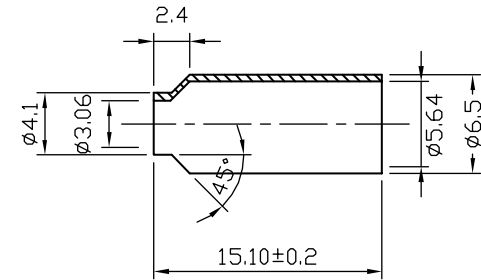

## MATERIAL & FINISH

BODY : ZINC ALLOY, NICKEL PLATING  
 PIN : BRASS, GOLD PLATING  
 DIELECTRIC : DELRIN  
 WASHER : BRASS, NICKEL PLATING  
 FERRULE : BRASS, NICKEL PLATING  
 SPRING : SK-5  
 GASKET : SI RUBBER

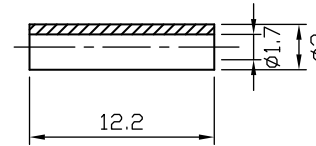
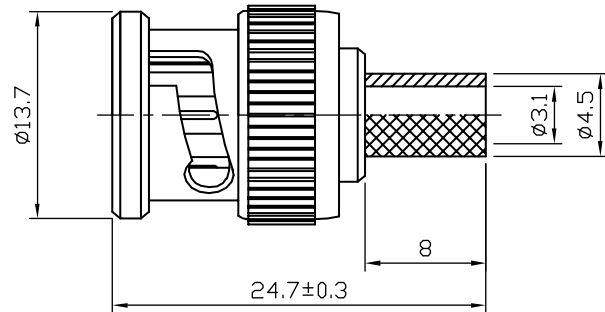
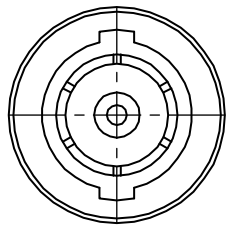
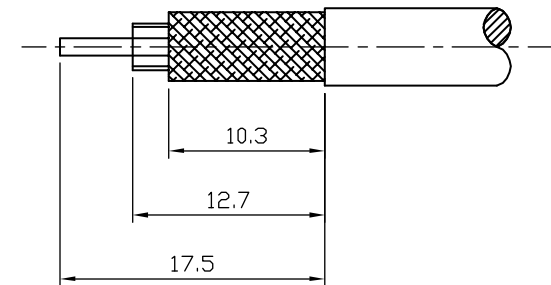
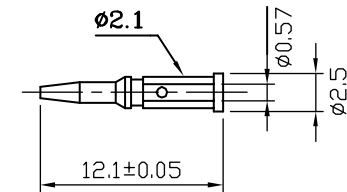
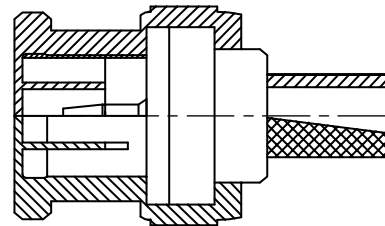

## SPECIFICATION

IMPEDANCE : 50/75Ω  
 VOLTAGE RATING : 500V RMS  
 FREQUENCY RANGE : 0~4 GHz  
 INTERFACE PER MIL-C-39012C  
 FOR RG-174 CABLE

Phone 1-800-809-2751



Fax 1-510-440-0579

www.connect-tech-products.com • info@connect-tech-products.com

4428 Technology Drive • Fremont, CA 94538, USA • 510-498-8815 • Fax: 510-440-0579